

0 600 822 203

Stand } 99-06
Issue } 99-01-19

Fig./Abb. 1

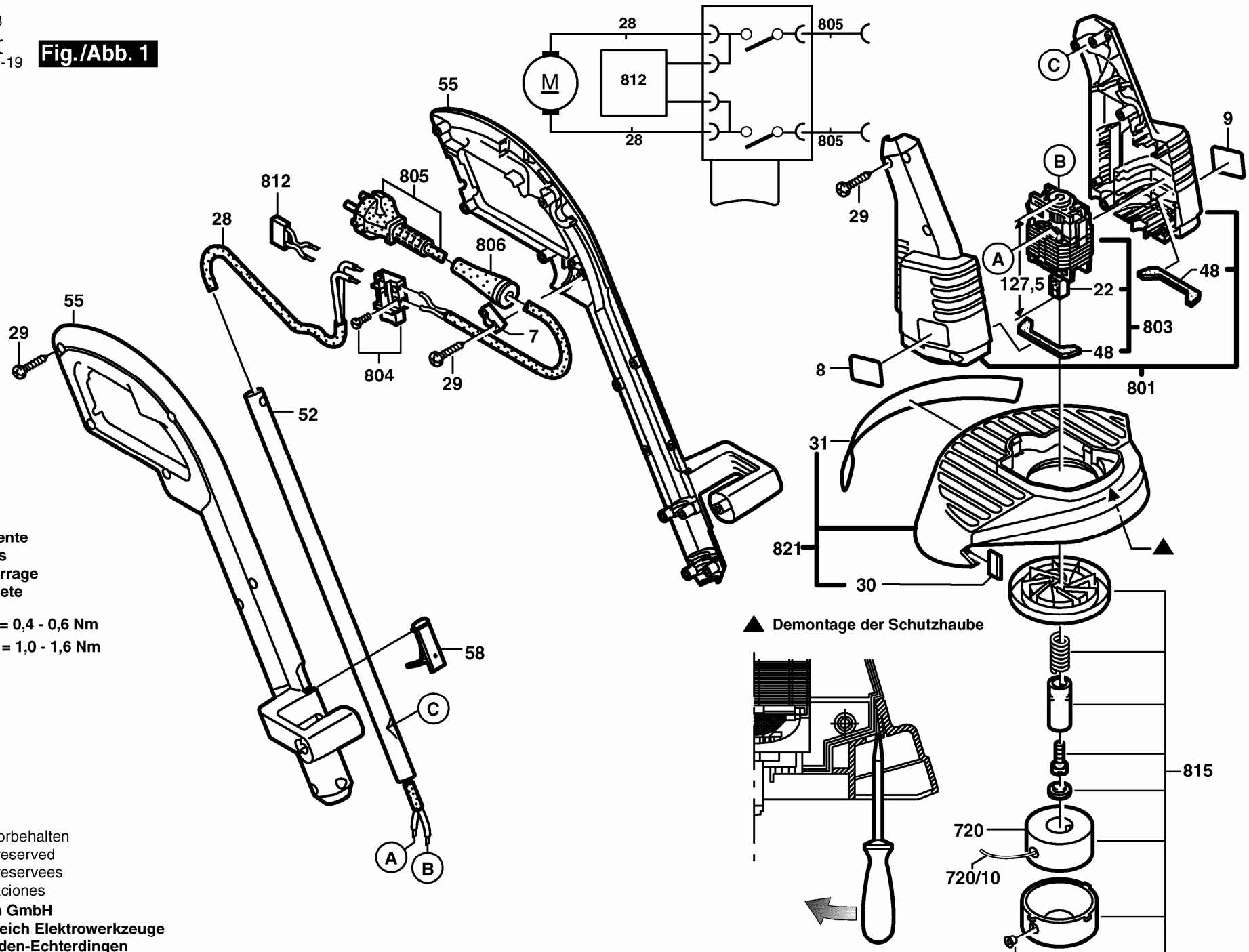

Anzugsmomente
Torque values
Couple de serrage
Pares de apriete

Pos. 804/010 = 0,4 - 0,6 Nm
29 = 1,0 - 1,6 Nm

Änderungen vorbehalten
Modifications reserved
Modifications reserves
Salvo modificaciones
Robert Bosch GmbH
Geschäftsbereich Elektrowerkzeuge
70745 Leinfelden-Echterdingen

▲ Demontage der Schutzhaube

